

ROTALIGN® PRO

The ultimate in laser shaft alignment



Taking professional alignment to a higher level

As maintenance technicians' job responsibilities grow more varied, so does the need for an alignment system to do more. Most systems can deal with horizontal and vertical machinery and measure soft foot. Some can even measure misalignment uncoupled – but the new ROTALIGN® PRO does much more. It lets you align machine trains of up to six machines, calcu-

lating which machine feet to move in order to minimize correction effort. It not only measures soft foot but also analyzes it and suggests corrective action. It can even compute thermal growth for you. But ROTALIGN® PRO does not stop at the alignment of rotating machines: it also features an optional program for accurate single-pass straightness measurement.

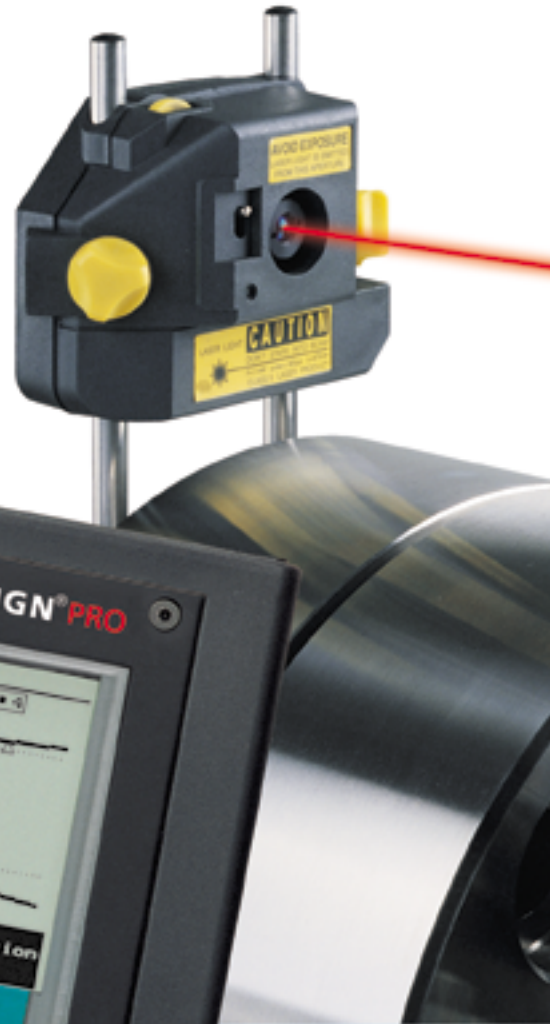

Precise a

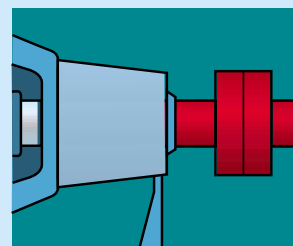
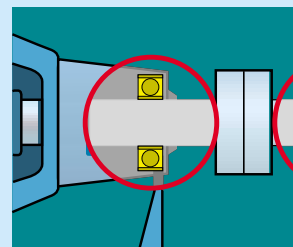

level

Expertise for everyone

ROTALIGN® PRO makes quick, accurate shaft alignment a simple affair for new users, yet offers experts the functions they need in order to master special challenges such as machine trains and cardan shafts, flange-mounted machines and nonrotatable shafts – all just a few keystrokes away.



Alignment pays for itself!

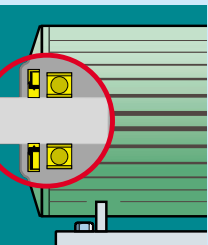

Reduces bearing and seal damage

Minimizes energy loss

Cuts production downtime

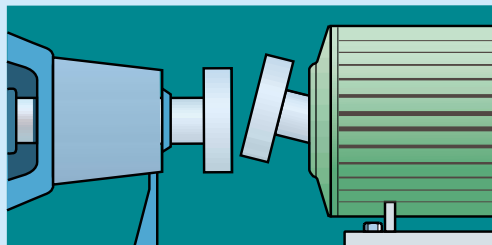
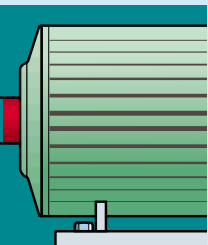

Aligns horizontal & vertical machines!

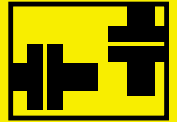

Aligns coupled & uncoupled shafts!

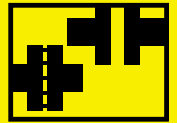

Rotate shafts only a quarter-turn in any position!

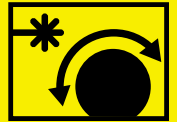

Buy it today – use it today!



Machine train alignment!

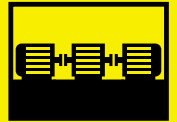

Built-in soft foot expertise!



Thermal growth computation!

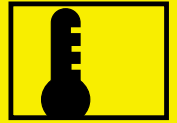

Cordless measurement!



Cardan shaft alignment!

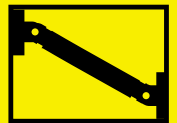

Measure straightness with ease!

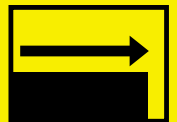

Take Command with PC software!



ROTALIGN® PRO does it all!

3-key alignment: Quicker, easier, more flexible

1



Define any machine in record time!

Quick and easy setup

The job setup screen gets you up and running quickly with a clear, yet detailed diagram of the machines to be aligned. The same screen also lets you add machines to new or existing trains, specify coupling types and dimensions, RPM, amount of thermal growth and much more!

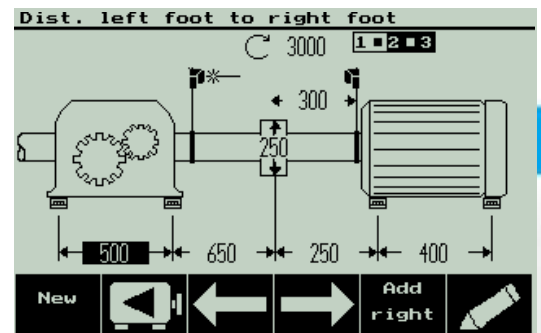

2



Automatic measurement with total control

No machine too 'exotic'

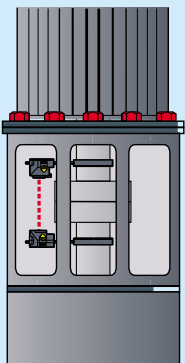

Flange-mounted machines: a breeze to align!

Precise alignment of vertical machines and horizontal flange-mounted machines was never this easy! ROTALIGN® PRO shows shimming corrections for each flange bolt and lets you monitor lateral positioning 'live' on screen as well.

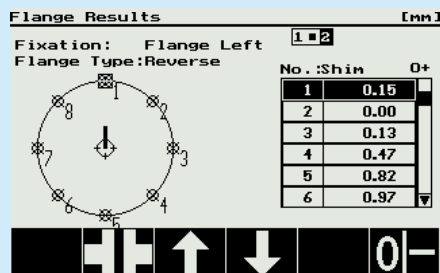

Measures all by itself!

Simply adjust the laser beam, then rotate the shafts to begin measurement: in less than a quarter-turn, ROTALIGN® PRO automatically registers enough points to determine alignment accurately.

3

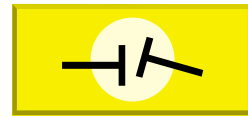

Alignment results in their most usable form

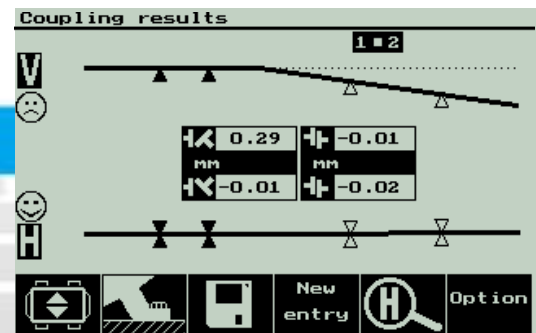

The whole picture at a glance

ROTALIGN® PRO shows you the complete alignment condition in a single clear screen: coupling misalignment, machine foot corrections, even tolerance compliance indicated by 'happy faces' for horizontal and vertical planes.

Ultimate alignment convenience

Machine templates save setup time!

Why spend time entering every machine detail by hand before each alignment job? Machine templates offer predefined configurations including machine types/names, identification tags, dimensions, tolerances, targets etc.

Choose your machine!

Select your specific machine type and its detailed depiction from a built-in selection. This makes for especially convenient handling of multi-element machine trains and also enhances your alignment reports.

Truly traceable results, every step of the way!

Document every step of the entire job with the 'Job Record' feature of ROTALIGN® PRO, complete with comments (e.g. 'as found,' 'as left' etc.) for ISO-compliant traceability.

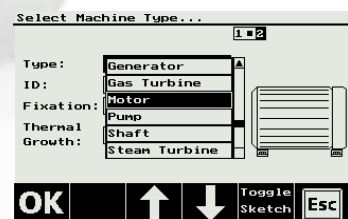
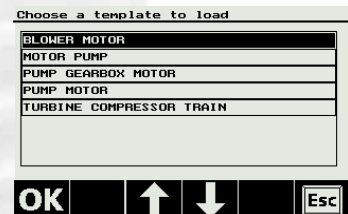

Job Record

Info	Date	Time
as found	20.05.1998	08:55
after soft-foot ck.	20.05.1998	09:06
after shimming	20.05.1998	09:21
after move	20.05.1998	09:28
as left	20.05.1998	09:34
Current Selection		

View New Entry ↑ ↓

The right brackets for all your machines



Quite possibly the only bracket you'll ever need: the standard ROTALIGN® PRO compact chain-type bracket ALI 2.891set uses interchangeable parts to fit onto shafts and solid couplings ranging from 15 mm to 500 mm (5/8" to 20") in diameter in a matter of seconds!



Instant mounting on any ferromagnetic surface: just place the time-saving ALI 2.112 compact magnetic brackets onto coupling flanges or shaft faces and you're all set! Powerful magnets hold sensors rigidly in place for measurement, yet allow extremely easy, flexible adjustment.



Shafts can't be rotated? No problem with ROTALIGN® PRO! Simply place the ALI 2.230 magnetic sliding bracket onto the coupling flange or shaft end and slide it around the circumference to take measurements in seconds. Suitable for shaft/coupling diameters from approx. 80 mm (3 1/8") on up.



PRO as in 'protection'

ROTALIGN® PRO means industrial-strength alignment: its shockproof, IP67 rubberized components remain unaffected by water spray, grime and solvents, while the rugged flat keyboard gives a positive response even through heavy work gloves. The lockable flight case (shown here in optional matte aluminum) keeps all standard system components and frequently-used accessories in perfect order.



Alignment advantages through technology

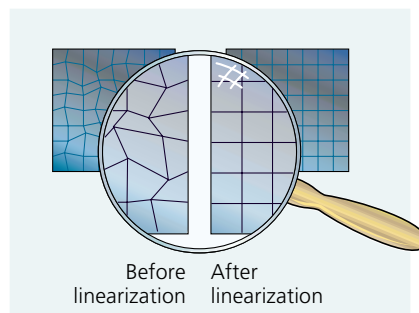

High-precision detector gives unparalleled accuracy

Even the best commercially-available position detectors are no match for those linearized by the unique PRÜFTECHNIK AG process: each individual detector undergoes a complex mathematical optimization procedure to give exceptional accuracy over a large measurement area. This enables you to perform alignment reliably at separations of 10 m (33 ft.) and beyond!

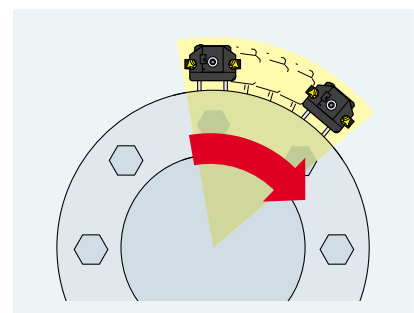

Ultimate flexibility: Measure in a quarter-turn or less!

Two built-in electronic inclinometers continuously keep track of the shaft rotation angle for each measurement of laser beam position. This ensures that alignment corrections are calculated precisely for vertical and horizontal directions, and thanks to the patented measurement techniques, you can even measure

- in one continuous sweep!
- in less than 1/4 turn!
- in either direction!
- from any starting position!

PC support: before, during & after

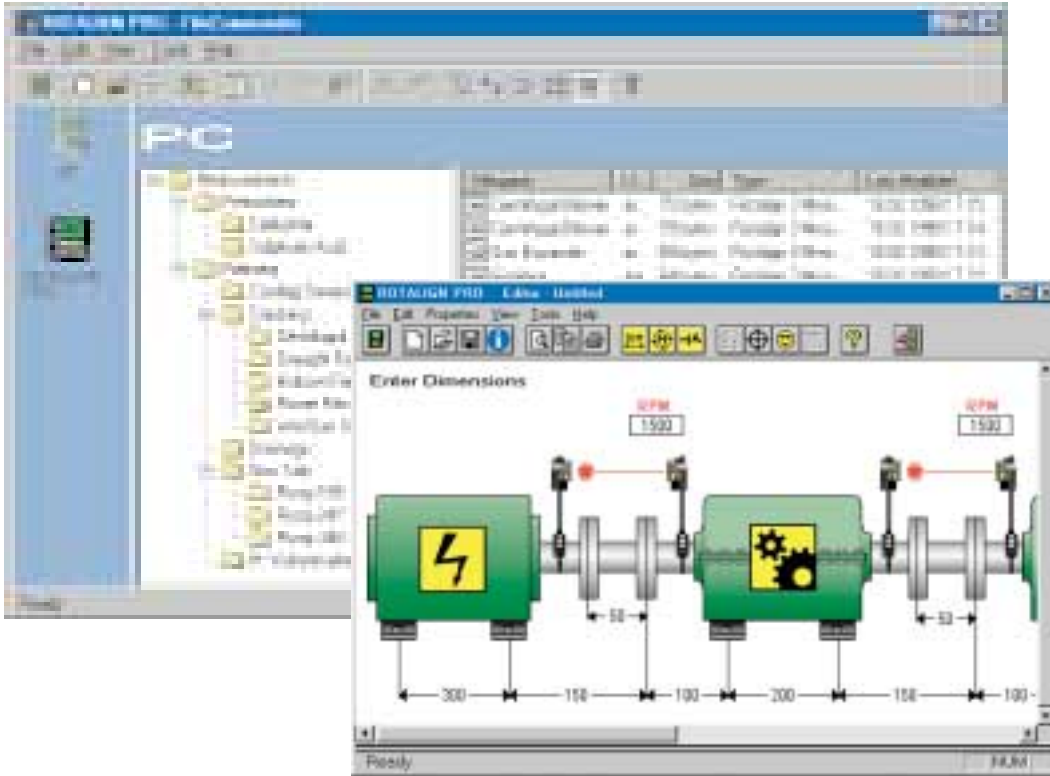

The timesaving PC partner: ROTALIGN® PRO Commander

ROTALIGN® PRO Commander software saves alignment time at the job site by giving you complete control with the point-and-click ease of Windows™ 95 or NT! Display and store alignment results, customize the ROTALIGN® PRO computer and specify all aspects of the machines to be measured. Define machine templates, even for entire trains of up to six machines in one file. Select among alignment tolerance tables or modify them to suit your particular circumstances. Machine definitions and measurement results are logically organized by plant, area and machine train or aggregate.

Alignment power for any situation

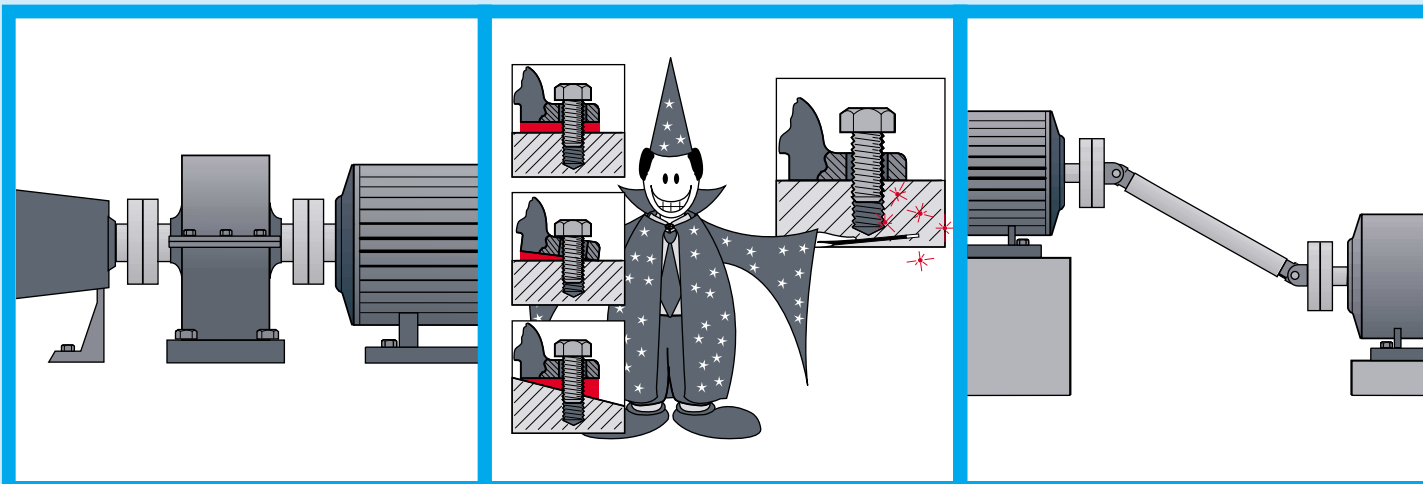

Machine train alignment!

ROTALIGN® PRO handles trains of up to 6 machines (5 couplings), complete with specific tolerances, targets, names and icons for each machine. Machine trains can have horizontal or vertical shafts, with or without flange-mounted (C-face) machines!

Built-in soft foot expertise!

The new Soft Foot Wizard (patent pending) helps you resolve difficult machine frame distortion problems on the spot. One soft foot, two soft feet, rough adjustment of severe soft foot, or induced soft foot from piping strain or severe misalignment: the Soft Foot Wizard recognizes such situations and gives you expert recommendations on how to handle them.

Align cardan shafts

Cardan shafts save space by running at an angle. But misalignment can pose a serious threat (especially to electronically-controlled synchronous and asynchronous AC drive motors) due to rapid RPM fluctuation of the drive shaft. ROTALIGN® PRO masters cardan shafts with ease thanks to a new special function and optional ALI 2.893SET large-offset brackets.

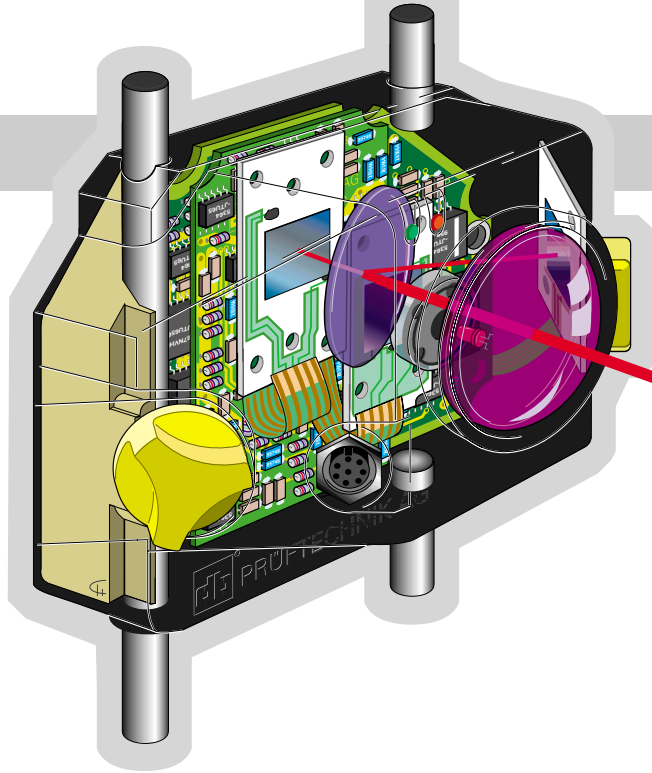

Advanced design features mean fast, accurate results

ROTALIGN® PRO measures alignment by tracking to the nearest 1/1000 mm laser beam displacement over the surface of a position detector as the shafts are turned. The more accurately this measurement is made, the more reliable the alignment corrections will be. And accuracy is enhanced by features like dual inclinometers and a quadruple-axis position detector with ultra-precise linearization.

Straightness measurement with ease!

Now measure straightness (vertical and horizontal) of ways, beds and other applications, far more quickly and accurately than with conventional taut wires, theodolites or even other laser methods. Optional straightness module ALI 3.630SET includes adjustable brackets that fit a wide range of workpieces.

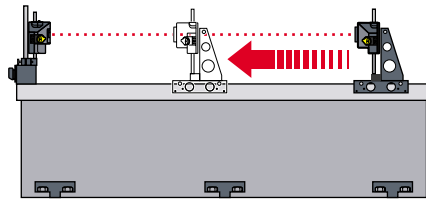

DEVIATION FROM REFERENCE LINE	
[mm]	PT 3 Y=0.03
+0.10	X X X X X X X X
-0.10	X X X X X X X X
CURRENT POSITION 450 X=-0.22	
+0.50	X X X X X X X X
-0.50	X X X X X X X X

Move Fix ← → Laser Line More

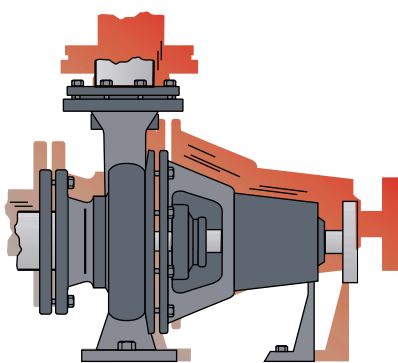

Thermal growth computation!

No specs available for compensation of thermal effects? Let ROTALIGN® PRO compute thermal growth based on temperature change, machine geometry and material coefficient of thermal expansion - even when machine structural components are made of different materials!

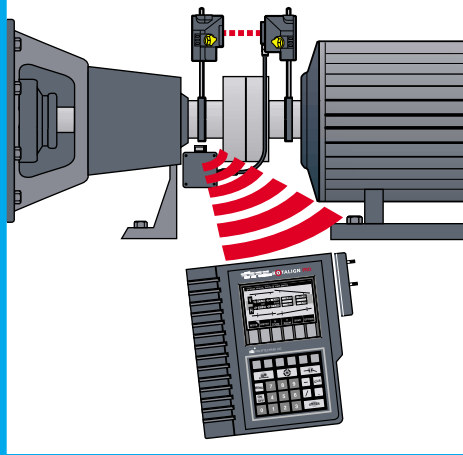

Cordless measurement!

No more cable to constantly disconnect and reconnect when large shafts require use of turning gears for measurement rotation or in "hot" (radiation) areas. The optional infrared data transmission link ALI 4.609SET is invaluable for passing alignment readings from the measurement receiver to the ROTALIGN® PRO computer, reliably and with no cable connections.

Straightforward results

ROTALIGN® PRO shows you vertical and horizontal offsets at a glance, based upon optimized correction values or your choice of stationary points - and guides you through corrections 'live' on screen as well in both horizontal and vertical directions at the same time.

ROTALIGN® PRO Technical data

Laser emitter

Laser	GaAlAs semiconductor laser
Wavelength	670 nm (typical)
Beam diameter	5 mm
Beam divergence	< 0.3 mrad
Beam power	< 1 mW
Laser safety class	Class 2; FDA 21CFR 1000 and 1040
Safety precautions	Do not look into laser beam.
Power supply	9V block battery, IEC 6LR61 (alkaline or lithium)
Operating time, continuous	80 hours, depending upon battery type
Temperature range	0°C - 60°C (32°F - 140°F)
Weight	Approx. 165 g (5.8 oz.)

Laser receiver

Directions of 5-axis detector measurement	2 planes (4 displacement axes) 1 inclination 360° (angle to plumb)
Two detector areas	18 mm x 18 mm (0.7" x 0.7") each
Separation between measurement planes	Approx. 160 mm (6 1/4")
Resolution	1 µm (0.04 mil); angular 10 µRad
Error	< 2%
Error rotation angle	< 2°
Measurement rate	Approx. 20 Hz
Temperature range	0°C - 60°C (32°F - 140°F)
Weight	Approx. 190 g (6.7 oz.)

Laser emitter/receiver

Max. measurement separation between emitter and receiver	10 m (33 ft.)
Measurement stability	Ensured by temperature-stabilized light metal housing
Environmental protection	Shockproof, waterproof, dustproof (IP 67)
Protection from ambient light	Yes
Dimensions, W x H x D	Approx. 105 x 67 x 47 mm (4 1/8" x 2 5/8" x 1 7/8")

Computer

LCD screen	60 x 95 mm (2 3/8" x 3 3/4"), 200 x 320 pixels, with contrast control
LED indicators	Main battery low, auxiliary battery low, battery charging, 'sleep' mode
Power conservation	'Sleep' mode blanks screen, interrupts measurement after user-defined period of nonuse; automatic shutoff after a further user-defined period
Keyboard	6 variable-function keys (soft keys) 20 fixed-function keys (hard keys)
External interface	RS-232C (serial) and parallel printer interface for graphics or text reports and instant screen dumps.
Memory	Nonvolatile 4MB PCMCIA card, stores over 1000 measurement sets with labels, comments etc.
Power supply	6x 1.5V (IEC LR 14) Size "C" (alkaline standard, NiCad rechargeable optional) Optional: Lead-acid block battery rechargeable by computer Optional: ALI 3.576 mains adapter for 110V/220V (switchable), output 400 mA min. at 12V ± 5%
Auxiliary battery	9V block (IEC 6LR61), provides 20 - 40 min. operation
Backup battery	Lithium (laser welded type), maintains data memory for 5 years

Operating time, computer/receiver ¹	50 hours (alkaline batteries) 25 hours (NiCad batteries) 9 hours (lead-acid battery pack)
Environmental protection	Waterproof, dustproof, shockproof (IP67)
Operating temperature	0° C - 45° C (32° F - 113° F)
Dimensions, W x H x D	Approx. 210 x 240 x 70 mm 8 1/4" x 9 1/2" x 2 3/4"
Weight with battery	Approx. 1.75 kg (3.8 lb.)

Carrying case

Standard	ABS, drop tested (2 m / 6 1/2 ft.)
Optional	Aluminum shell
	Both cases feature 2 key locks and 1 combination lock.
Case dimensions, W x H x D	Approx. 550 x 380 x 205 mm 21 5/8" x 15" x 8 1/8"
Weight, including all standard parts	Approx. 11.2 kg (24.6 lb.)

Options

Non-contact IR data transmission from receiver to computer
Max. range Approx. 8 m (26 ft.), depending upon surrounding conditions.

Intrinsic safety



EEx ib IIC T4
Approx. U.S. equivalent: NEC Article 500-4, Class 1, Division 1, groups D,C,B,A and special safeguards T4

ROTALIGN®PRO Commander PC software ALI 3.592SET lets you:

- Back up and restore machine alignment data files under Microsoft Windows
 - Issue alignment reports
 - Display alignment results
 - Configure the ROTALIGN®PRO computer
 - Define machine templates for quick setup
- Includes serial interface cable and adapter.

¹ Based upon an operating cycle of
25% measurement
25% computation and
50% 'sleep' mode



ISO 9001



Calibration checking traceable to your national standards

All measurement systems need periodic verification of accuracy to ensure reliability of results; ISO standards even require it. ROTALIGN® PRO calibration can be traced at any time to national or international norms such as ISO 9000.

The world of laser shaft alignment and more

The PRÜFTECHNIK Laser Alignment Product Catalog provides details on all standard systems and a full range of accessories designed to make for faster, easier and more accurate alignment in just about any situation.

Ask for your free copy today!

Printed in Germany ALI 9.642.06.98.10G

ROTALIGN® is a registered trademark of PRÜFTECHNIK Dieter Busch AG. No copying or reproduction of this information, in any form whatsoever, may be undertaken without express written permission of PRÜFTECHNIK AG. The information contained in this leaflet is subject to change without further notice due to the PRÜFTECHNIK policy of continuous product development. PRÜFTECHNIK products are the subject of patents granted or pending throughout the world.
© Copyright 1998 by PRÜFTECHNIK AG.

PRÜFTECHNIK AG
P.O. Box 12 63
D-85730 Ismaning, Germany
www.pruftechnik.com
Phone: +49 (0) 89 99 61 60
Fax: +49 (0) 89 99 61 62 00
eMail: info@pruftechnik.com

