

Portable Ultrasonic Flow Measurement of Liquids in Hazardous Areas

Portable instrument for non-invasive, quick ultrasonic flow measurement with clamp-on technology for all types of piping

Features

- Precise bi-directional and highly dynamic flow measurement with the non-intrusive clamp-on technology
- High precision at fast and slow flow rates, no temperature and zero drift
- Portable, easy-to-use flow transmitter with 2 flow channels, multiple inputs/outputs, an integrated data logger with a serial interface
- Extremely resistant carbon fiber housing
- Covered by ATEX zone 2 certification (Ⓔ II3G), IP65 protection - No hot work permit required for hazardous areas
- Compact and very lightweight, allowing the measuring system to be easily carried as personal luggage, e.g. for offshore visits
- Water and dust-tight (IP65); resistant against oil, many liquids and dirt
- Li-Ion battery provides up to 14 hours of measurement operation
- Automatic loading of calibration data and transducer detection for a fast and easy set-up (less than 5 min), providing precise and long-term stable results
- User-friendly design
- Transducers available for a wide range of inner pipe diameters (10...6500 mm) and fluid temperatures (-40...+200 °C)
- Rugged transducers (ATEX-Zone 1 und 2, resistant to rough environments, dust and humidity)
- Robust, water-tight (IP67) transport case with comprehensive accessories
- HybridTrek automatically switches between transit time and NoiseTrek mode of measurement when high particulate flows are encountered
- QuickFix for fast mounting of the flow transmitter in difficult conditions

Applications

Designed for the following industries:

- Upstream (on- and offshore)
- Midstream and downstream (pipelines and refineries)
- Chemical industry
- Energy sector (e.g. HVAC, geothermal, power plants)



FLUXUS F608 supported by handle



Measurement with transducers mounted by the portable Variofix VP



Measurement with the flow transmitter fixed to the pipe by the QuickFix pipe mounting fixture

Table of Contents

Function	3
Measurement Principle	3
Calculation of Volumetric Flow Rate	3
Number of Sound Paths	4
Typical Measurement Setup	5
Flow Transmitter	6
Technical Data	6
Dimensions	8
Standard Scope of Supply	8
Adapters (optional).....	9
Transducers.....	11
Transducer Selection	11
Transducer Order Code	12
Technical Data	13
Transducer Mounting Fixture	18
Coupling Materials for Transducers.....	19
Connection Systems.....	20
Transducer Cable.....	20
Clamp-on Temperature Probe (optional)	21

Function

Measurement Principle

Transit Time Difference Principle

In order to measure the flow of a medium in a pipe, ultrasonic signals are used, employing the transit time difference principle. Ultrasonic signals are emitted by a transducer installed on the pipe and received by a second transducer. These signals are emitted alternately in the flow direction and against it.

As the medium in which the signals propagate is flowing, the transit time of the ultrasonic signals in the flow direction is shorter than against the flow direction.

The transit time difference, Δt , is measured and allows the flowmeter to determine the average flow velocity along the propagation path of the ultrasonic signals. A flow profile correction is then performed in order to obtain the area averaged flow velocity, which is proportional to the volumetric flow rate.

Two integrated microprocessors control the entire measuring process. This allows the flowmeter to remove disturbance signals, and to check each received ultrasonic wave for its validity which reduces noise.

HybridTrek

If the gaseous or solid content in the medium increases occasionally during measurement, a measurement with the transit time difference principle is no longer possible. NoiseTrek mode will then be selected by the flowmeter. This measurement method allows the flowmeter to achieve a stable measurement even with high gaseous or solid content

The transmitter can switch automatically between transit time and NoiseTrek mode without any changes to the measurement setup.

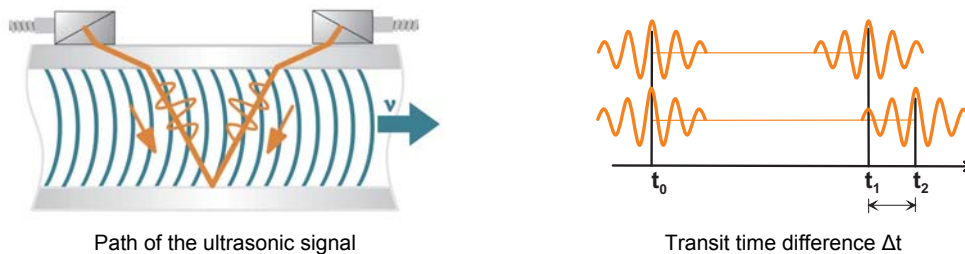

Calculation of Volumetric Flow Rate

$$Q = k_{Re} \cdot A \cdot k_a \cdot \Delta t / (2 \cdot t_{fl})$$

where:

- Q - volumetric flow rate
- k_{Re} - fluid mechanics calibration factor
- A - cross-sectional pipe area
- k_a - acoustical calibration factor
- Δt - transit time difference
- t_{fl} - transit time in the medium

Number of Sound Paths

The number of sound paths is the number of transits of the ultrasonic signal through the medium in the pipe. Depending on the number of sound paths, the following methods of installation exist:

- **reflection mode**

The number of sound paths is even. Both of the transducers are mounted on the same side of the pipe. Correct positioning of the transducers is easier.

- **diagonal mode**

The number of sound paths is odd. Both of the transducers are mounted on opposite sides of the pipe. In the case of a high signal attenuation by the medium, pipe and coatings, diagonal mode with 1 sound path will be used.

The preferred method of installation depends on the application. While increasing the number of sound paths increases the accuracy of the measurement, signal attenuation increases as well. The optimum number of sound paths for the parameters of the application will be determined automatically by the transmitter.

As the transducers can be mounted with the transducer mounting fixture in reflection mode or diagonal mode, the number of sound paths can be adjusted optimally for the application.

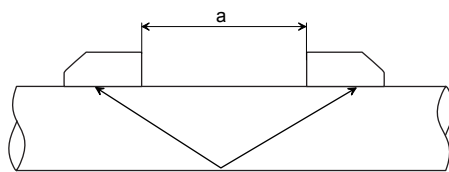

Reflection mode, number of sound paths: 2

a - transducer distance

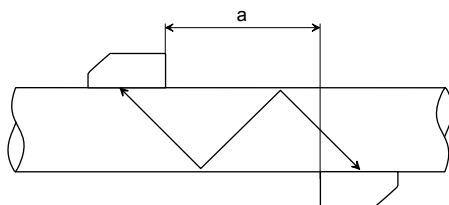

Diagonal mode, number of sound paths: 3

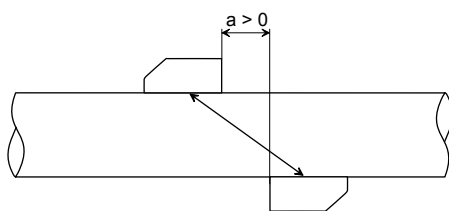

diagonal mode, number of sound paths: 1

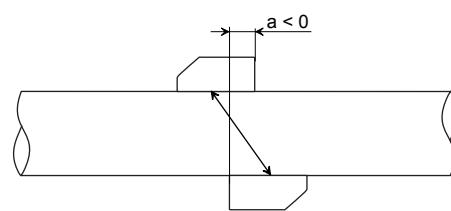

diagonal mode, number of sound paths: 1,
negative transducer distance

Typical Measurement Setup

ATEX zone 2

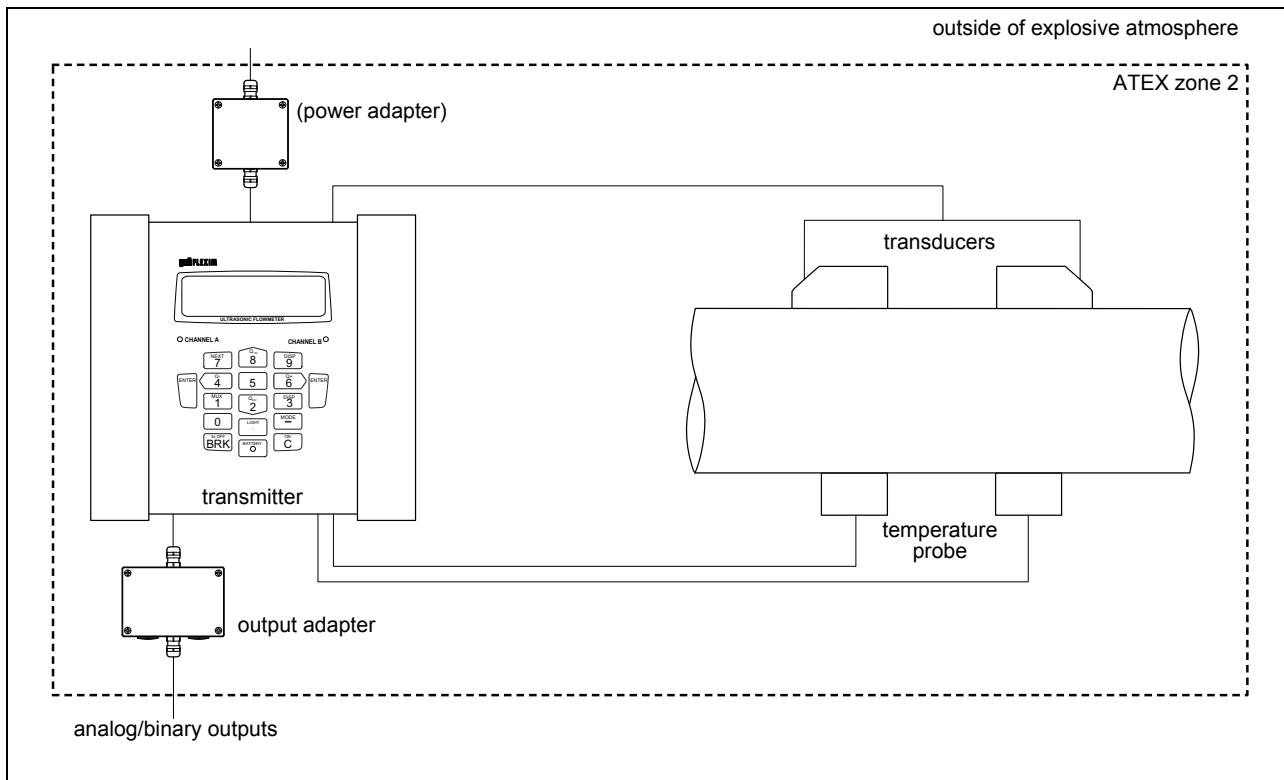

ATEX zone 2/ATEX zone 1

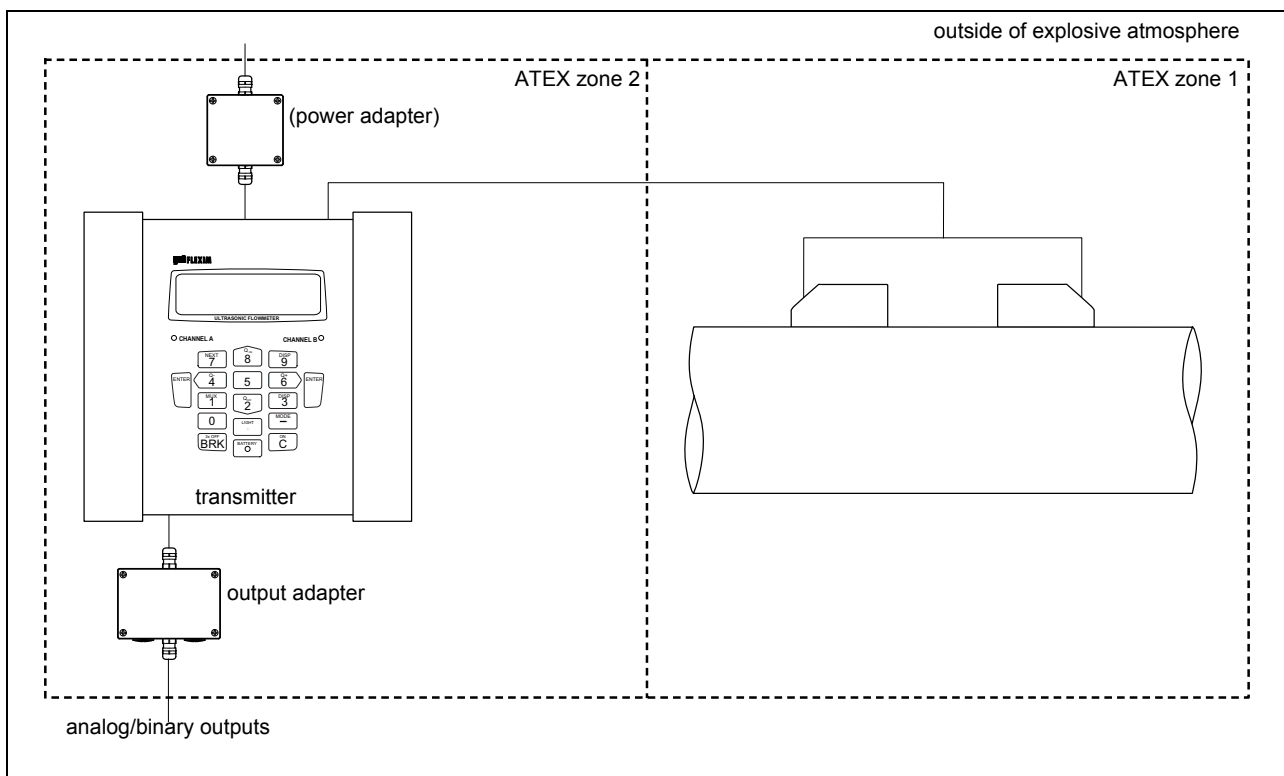

FLUXUS	F608**-A2
measuring functions	
physical quantities	volumetric flow rate, mass flow rate, flow velocity, heat flow (if temperature inputs are installed)
totalizer	volume, mass, optional: heat quantity
calculation functions	average, difference, sum
diagnostic functions	sound speed, signal amplitude, SNR, SCNR, standard deviation of amplitudes and transit times
data logger	
loggable values	all physical quantities, totalized values and diagnostic values
capacity	> 100 000 measured values
communication	
interface	RS232/USB
serial data kit	
software (all Windows™ versions)	- FluxData: download of measurement data, graphical presentation, conversion to other formats (e.g. for Excel™) - FluxKoeff: creating medium data sets
cable	RS232
adapter	RS232 - USB
transport case	
dimensions	500 x 400 x 190 mm
outputs	
	The outputs are galvanically isolated from the transmitter.
number	see standard scope of supply on page 8
accessories	output adapter (optional)
current output	
range	0/4...20 mA
accuracy	0.1 % of reading ±15 µA
passive output	$U_{ext} = 4...9 \text{ V}$, depending on R_{ext} $R_{ext} < 200 \Omega$
binary output	
optorelay	26 V/100 mA
binary output as alarm output - functions	limit, change of flow direction or error
binary output as pulse output - pulse value - pulse width	0.01...1000 units 1...1000 ms
inputs	
	The inputs are galvanically isolated from the transmitter.
number	see standard scope of supply on page 8
temperature input	
type	Pt100/Pt1000
connection	4-wire
range	-150...+560 °C
resolution	0.01 K
accuracy	±0.01 % of reading ±0.03 K
intrinsic safety parameters	$U_o = 22 \text{ V}$, $I_o = 6 \text{ mA}$, $P_o = 33 \text{ mW}$, $C_o = 450 \text{ nF}$, $L_o = 10 \mu\text{H}$ $C_i = 1.8 \text{ nF}$, $L_i = 10 \mu\text{H}$

Dimensions

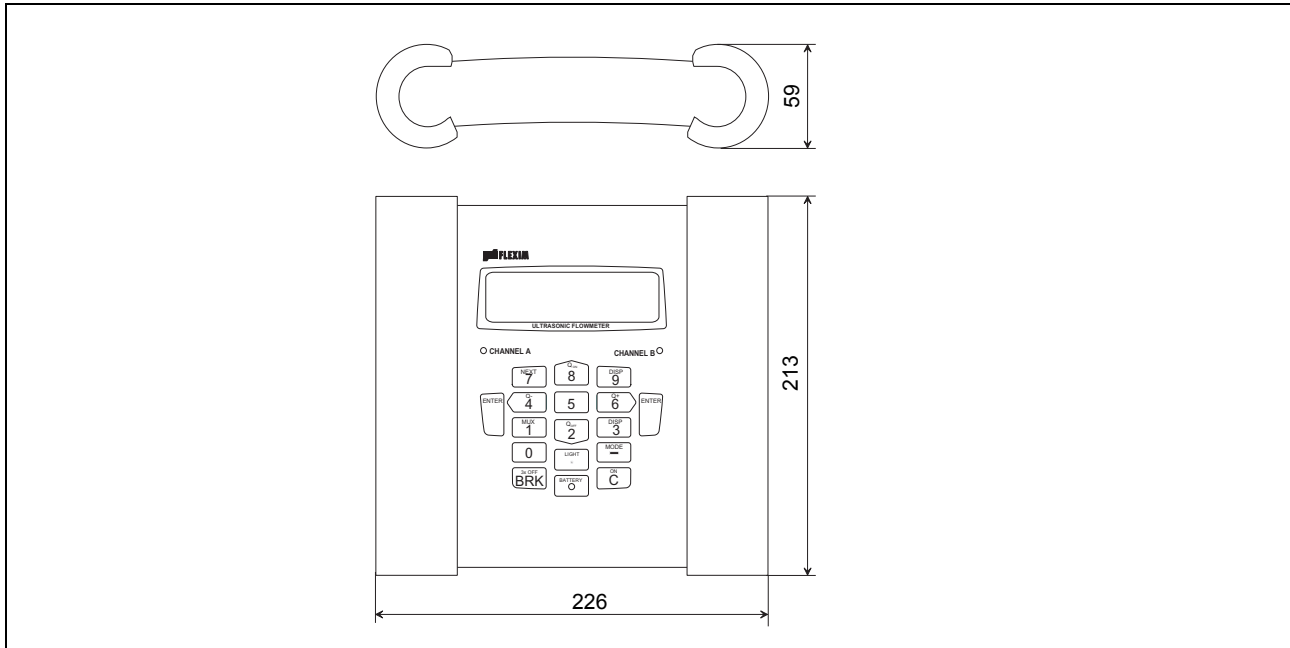

in mm

Standard Scope of Supply

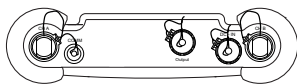
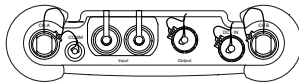
	F608 Standard	F608 Energy
order code	FLUXUS F608**-A22-3N-NN-2D-II-NN-NN	FLUXUS F608**-A22-3N-TT-2D-II-NN-NN
application	all flow measurements on liquids	including energy calculator for BTU and heat measurements
outputs		
passive current output	2	2
binary output	2	2
inputs		
temperature input	-	2
accessories		
transport case	x	x
power supply unit, mains cable	x	x
battery	x	x
QuickFix pipe mounting fixture for transmitter	x	x
serial data kit	x	x
measuring tape	x	x
user manual, safety instructions, Quick Start Guide	x	x
connector board at the upper side of the transmitter		

Adapters (optional)

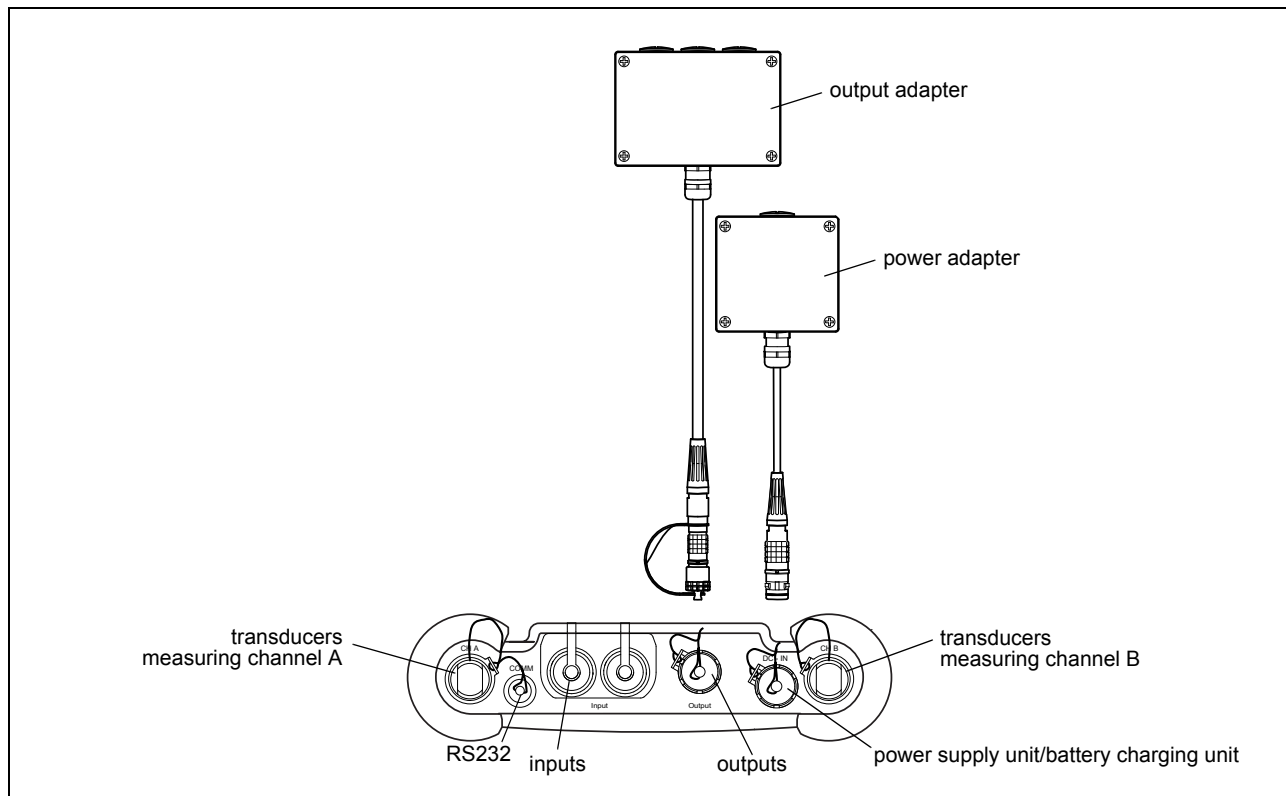

Technical Data

		output adapter	power adapter
technical type		OA608A2	PA608A2
dimensions		see dimensional drawing	
weight	kg	0.36	0.29
material			
housing		polyester	
gasket		silicone	
degree of protection according to IEC/EN 60529		IP66	
operating temperature			
min.	°C	-20	
max.	°C	+90	
explosion protection			
A	zone	2	
T	marking	CE (Ex) II3G Ex nA II T6 Gc Ta -20...+60 °C	
X	type of protection	non sparking	

Dimensions

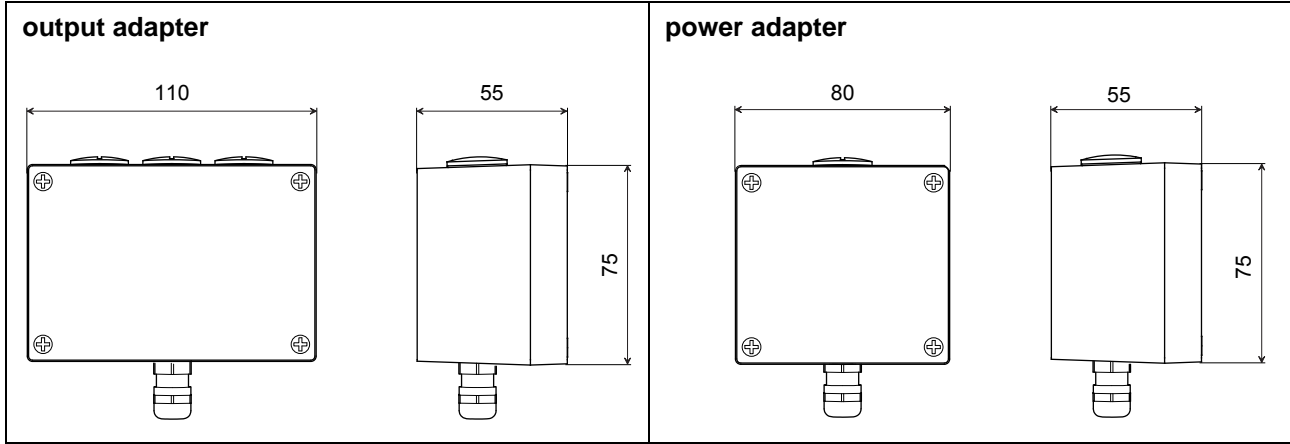

in mm

Terminal Assignment

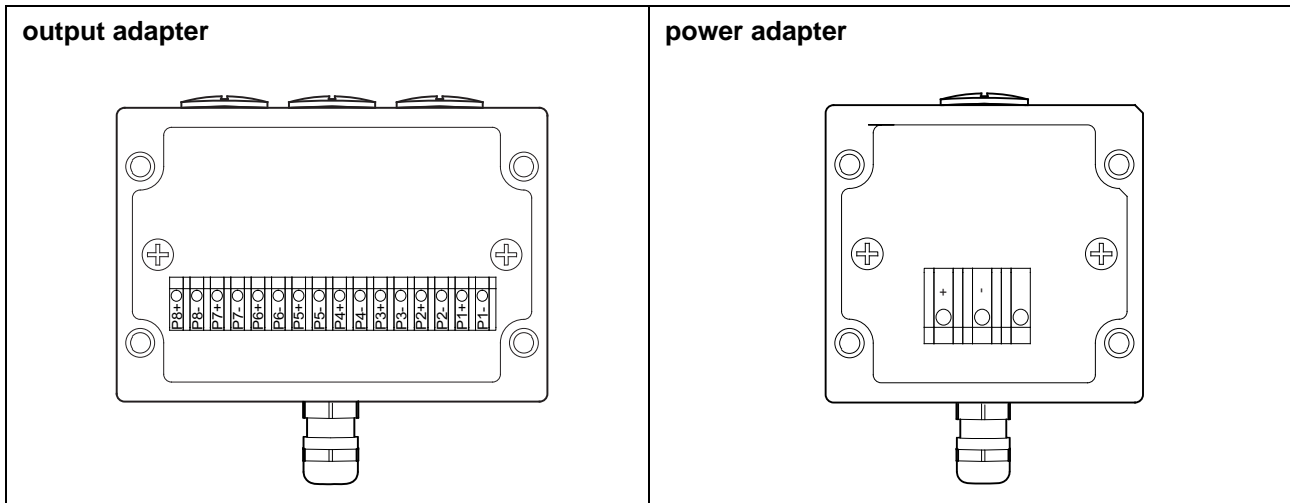

Transducers

Transducer Selection

transducer order code

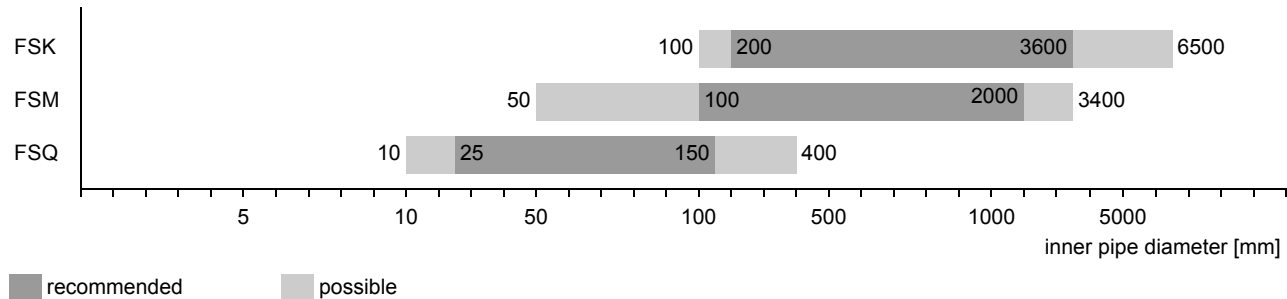

Technical Data

Shear Wave Transducers (zone 1)

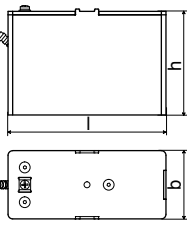
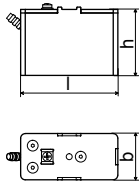
technical type		CDK1NW1	CLK1NW1	CDM2NW1	CLM2NW1
order code		FSK-NA1NL	FSK-NA1NL/LC	FSM-NA1NL	FSM-NA1NL/LC
transducer frequency	MHz	0.5		1	
inner pipe diameter d					
min. extended	mm	100		50	
min. recommended	mm	200		100	
max. recommended	mm	3600		2000	
max. extended	mm	6500		3400	
pipe wall thickness					
min.	mm	-		-	
max.	mm	-		-	
material					
housing		PEEK with stainless steel cap and transducer shoe 304 (1.4301)		PEEK with stainless steel cap and transducer shoe 304 (1.4301)	
contact surface		PEEK		PEEK	
degree of protection according to IEC/EN 60529		IP65		IP65	
transducer cable					
type		1699	1699	1699	1699
length	m	5	9	4	9
dimensions					
length l	mm	136.5		84	
width b	mm	59		40	
height h	mm	90.5		59	
dimensional drawing					
operating temperature					
min.	°C	-40		-40	
max.	°C	+130		+130	
temperature compensation		x		x	
explosion protection					
transducer		FSK-NA1NL	FSK-NA1NL/LC	FSM-NA1NL	FSM-NA1NL/LC
category		gas: 2/3G dust: 2D		gas: 2/3G dust: 2D	
EPL		Gb/Gc Db		Gb/Gc Db	
zone		1/2 21		1/2 21	
explosion protection temperature (pipe surface)					
min.	°C	-55		-55	
max.	°C	+180		+180	
marking		CE 0637; Ex q nA IIC T6...T2 Gb/Gc II2D Ex tb IIIC TX		CE 0637; Ex q nA IIC T6...T2 Gb/Gc II2D Ex tb IIIC TX	
certification		IBExU10ATEX1162 X		IBExU10ATEX1162 X	
type of protection		gas: powder filling, non sparking dust: protection by enclosure		gas: powder filling, non sparking dust: protection by enclosure	
necessary transducer mounting fixture		-		-	

Shear Wave Transducers (zone 1)

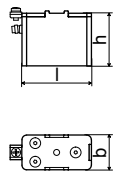
technical type		CDQ2NW1	CLQ2NW1
order code		FSQ-NA1NL	FSQ-NA1NL/LC
transducer frequency	MHz	4	
inner pipe diameter d			
min. extended	mm	10	
min. recommended	mm	25	
max. recommended	mm	150	
max. extended	mm	400	
pipe wall thickness			
min.	mm	-	
max.	mm	-	
material			
housing		PEEK with stainless steel cap and transducer shoe 304 (1.4301)	
contact surface		PEEK	
degree of protection according to IEC/EN 60529		IP65	
transducer cable			
type		1699	1699
length	m	3	9
dimensions			
length l	mm	70	
width b	mm	30	
height h	mm	47.5	
dimensional drawing			
operating temperature			
min.	°C	-40	
max.	°C	+130	
temperature compensation		x	
explosion protection			
transducer		FSQ-NA1NL	FSQ-NA1NL/LC
category		gas: 2/3G dust: 2D	
EPL		Gb/Gc Db	
zone		1/2 21	
explosion protection temperature (pipe surface)			
min.	°C	-55	
max.	°C	+180	
marking		CE 0637; Ex II2/3G Ex q nA IIC T6...T2 Gb/Gc II2D Ex tb IIIC TX	
certification		IBExU10ATEX1162 X	
type of protection		gas: powder filling, non sparking dust: protection by enclosure	
necessary transducer mounting fixture		-	

Shear Wave Transducers (zone 1, extended temperature range)

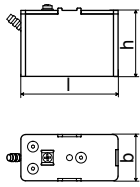
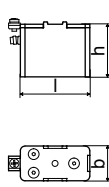
technical type		CDM2EW5	CLM2EW5	CDQ2EW5	CLQ2EW5
order code		FSM-EA1NL	FSM-EA1NL/LC	FSQ-EA1NL	FSQ-EA1NL/LC
transducer frequency	MHz	1		4	
inner pipe diameter d					
min. extended	mm	50		10	
min. recommended	mm	100		25	
max. recommended	mm	2000		150	
max. extended	mm	3400		400	
pipe wall thickness					
min.	mm	-		-	
max.	mm	-		-	
material					
housing		PI with stainless steel cap and transducer shoe 304 (1.4301)		PI with stainless steel cap and transducer shoe 304 (1.4301)	
contact surface		PI		PI	
degree of protection according to IEC/EN 60529		IP56		IP56	
transducer cable					
type		6111	6111	6111	6111
length	m	4	9	3	9
dimensions					
length l	mm	84		70	
width b	mm	40		30	
height h	mm	59		47.5	
dimensional drawing					
operating temperature					
min.	°C	-30		-30	
max.	°C	+200		+200	
temperature compensation		x		x	
explosion protection					
transducer		FSM-EA1NL	FSM-EA1NL/LC	FSQ-EA1NL	FSQ-EA1NL/LC
category		gas: 2/3G dust: 2D		gas: 2/3G dust: 2D	
EPL		Gb/Gc Db		Gb/Gc Db	
zone		1/2 21		1/2 21	
explosion protection temperature (pipe surface)					
min.	°C	-45		-45	
max.	°C	+225		+225	
marking		CE 0637; Ex II2/3G Ex q nA IIC T6...T2 Gb/Gc II2D Ex tb IIIA TX		CE 0637; Ex II2/3G Ex q nA IIC T6...T2 Gb/Gc II2D Ex tb IIIA TX	
certification		IBExU10ATEX1162 X		IBExU10ATEX1162 X	
type of protection		gas: powder filling, non sparking dust: protection by enclosure		gas: powder filling, non sparking dust: protection by enclosure	
necessary transducer mounting fixture		-		-	

Shear Wave Transducers (zone 2)

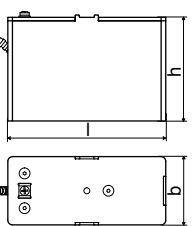
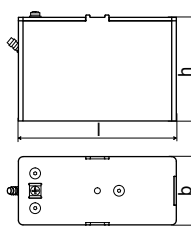
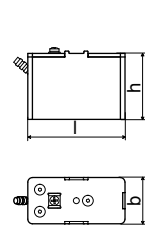
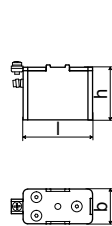
technical type		CDK1NH1	CLK1NH1	CDM2NH1	CDQ2NH1	
order code		FSK-NA2NL	FSK-NA2NL/LC	FSM-NA2NL	FSQ-NA2NL	
transducer frequency		MHz 0.5	0.5	1	4	
inner pipe diameter d						
min. extended		mm 100	100	50	10	
min. recommended		mm 200	200	100	25	
max. recommended		mm 3600	3600	2000	150	
max. extended		mm 6500	6500	3400	400	
pipe wall thickness						
min.		mm -	-	-	-	
max.		mm -	-	-	-	
material						
housing		PEEK with stainless steel cap and transducer shoe 304 (1.4301)	PEEK with stainless steel cap and transducer shoe 304 (1.4301)	PEEK with stainless steel cap and transducer shoe 304 (1.4301)	PEEK with stainless steel cap and transducer shoe 304 (1.4301)	
contact surface		PEEK	PEEK	PEEK	PEEK	
degree of protection according to IEC/EN 60529		IP65	IP65	IP65	IP65	
transducer cable						
type		1699	1699	1699	1699	
length		m 5	9	4	3	
dimensions						
length l		mm 136.5	136.5	84	70	
width b		mm 59	59	40	30	
height h		mm 90.5	90.5	59	47.5	
dimensional drawing						
operating temperature						
min.		°C -40	-40	-40	-40	
max.		°C +130	+130	+130	+130	
temperature compensation		x	x	x	x	
explosion protection						
transducer		FSK-NA2NL	FSK-NA2NL/LC	FSM-NA2NL	FSQ-NA2NL	
category		gas: 3G dust: 2D	gas: 3G dust: 2D	gas: 3G dust: 2D	gas: 3G dust: 2D	
EPL		Gc Db	Gc Db	Gc Db	Gc Db	
zone		2 21	2 21	2 21	2 21	
explosion protection temperature (pipe surface)						
min.		°C -55	-55	-55	-55	
max.		°C +190	+190	+190	+190	
A T E X	marking		CE 0637; Ex II3G Ex nA IIC T6...T2 Gc X II2D Ex tb IIIC TX Db	CE 0637; Ex II3G Ex nA IIC T6...T2 Gc X II2D Ex tb IIIC TX Db	CE 0637; Ex II3G Ex nA IIC T6...T2 Gc X II2D Ex tb IIIC TX Db	CE 0637; Ex II3G Ex nA IIC T6...T2 Gc X II2D Ex tb IIIC TX Db
	certification		IBExU10ATEX1163 X	IBExU10ATEX1163 X	IBExU10ATEX1163 X	IBExU10ATEX1163 X
	type of protection		gas: non sparking dust: protection by enclosure	gas: non sparking dust: protection by enclosure	gas: non sparking dust: protection by enclosure	gas: non sparking dust: protection by enclosure
	necessary transducer mounting fixture		-	-	-	-

Shear Wave Transducers (zone 2, extended temperature range)

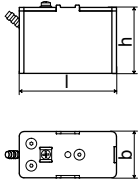
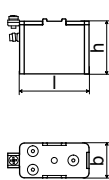
technical type		CDM2EH5	CDQ2EH5	
order code		FSM-EA2NL	FSQ-EA2NL	
transducer frequency	MHz	1	4	
inner pipe diameter d				
min. extended	mm	50	10	
min. recommended	mm	100	25	
max. recommended	mm	2000	150	
max. extended	mm	3400	400	
pipe wall thickness				
min.	mm	-	-	
max.	mm	-	-	
material				
housing		PI with stainless steel cap and transducer shoe 304 (1.4301)	PI with stainless steel cap and transducer shoe 304 (1.4301)	
contact surface		PI	PI	
degree of protection according to IEC/ EN 60529		IP56	IP56	
transducer cable				
type		6111	6111	
length	m	4	3	
dimensions				
length l	mm	84	70	
width b	mm	40	30	
height h	mm	59	47.5	
dimensional drawing				
operating temperature				
min.	°C	-30	-30	
max.	°C	+200	+200	
temperature compensation		x	x	
explosion protection				
A T E X	transducer		FSM-EA2NL	FSQ-EA2NL
	category		gas: 3G dust: 2D	gas: 3G dust: 2D
	EPL		Gc Db	Gc Db
	zone		2 21	2 21
	explosion protection temperature (pipe surface)			
	min.	°C	-45	-45
	max.	°C	+235	+235
	marking		CE 0637; Ex II3G Ex nA IIC T6...T2 Gc X II2D Ex tb IIIA TX Db	CE 0637; Ex II3G Ex nA IIC T6...T2 Gc X II2D Ex tb IIIA TX Db
	certification		IBExU10ATEX1163 X	IBExU10ATEX1163 X
	type of protection		gas: non sparking dust: protection by enclosure	gas: non sparking dust: protection by enclosure
necessary transducer mounting fixture		-	-	

Transducer Mounting Fixture

Order Code

1, 2	3	4	5	6	7...9	no. of character		
transducer mounting fixture	transducer	-	measuring mode	size	-	fixation	outer pipe diameter	description
VP								portable Variofix
	A							all transducers
			D					reflection mode or diagonal mode
			R					reflection mode
				M				medium
						C		chains
						N		without fixation
							055	10...550 mm
example								
VP	A	-	D	M	-	C	055	portable Variofix and chains
		-			-			

portable Variofix VP and chains

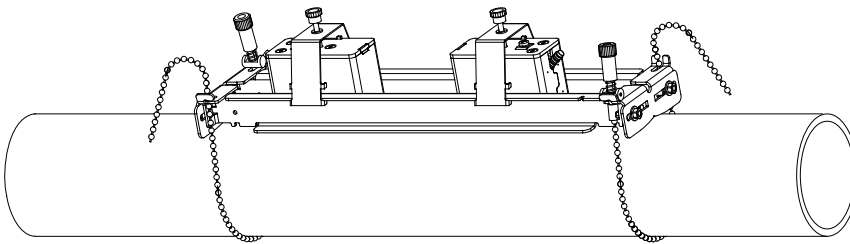

material: stainless steel 304 (1.4301), 301 (1.4310), 303 (1.4305)
 dimensions: 414 x 94 x 76 mm
 chain length: 2 m

Coupling Materials for Transducers

	normal temperature range (4th character of transducer order code = N)		normal temperature range (4th character of transducer order code = E)	
	< 100 °C	100...170 °C	< 150 °C	150...200 °C
< 2 h	coupling compound type N	coupling compound type E	coupling compound type E	coupling compound type E or H
< 24 h	coupling compound type N	coupling compound type E	coupling compound type E	coupling foil type VT

Technical Data

type	Order Code	operating temperature °C	material	remark
coupling compound type N	990739-1	-30...+130	mineral grease paste	
coupling compound type E	990739-2	-30...+200	silicone paste	
coupling compound type H	990739-3	-30...+250	fluoropolymer paste	
coupling foil type VT	990739-0	-10...+150, short-time peak max. 200	fluoroelastomer	for transducers with transducer frequency G, H, K
	990739-6			for shear wave transducers with transducer frequency M, P
	990739-14			for shear wave transducers IP68 and Lambwave transducers with transducer frequency M, P
	990739-15			for shear wave transducers with transducer frequency Q
	990739-5			for Lambwave transducers with transducer frequency Q

Connection Systems

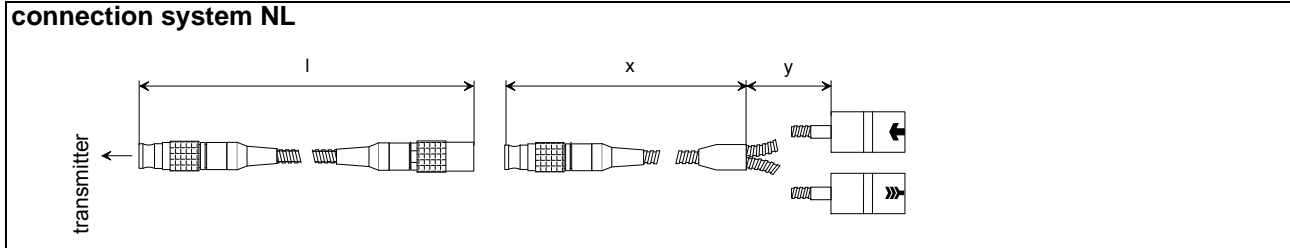

transducer frequency (3d character of transducer order code)		G, H, K			M, P			Q			S			
N L	cable length	m	x 2	y 3	l ≤ 10	x 2	y 2	l ≤ 10	x 2	y 1	l ≤ 10	x 1	y 1	l ≤ 10
	cable length (option LC)	m	2	7	≤ 10	7	2	≤ 10	8	1	≤ 10	-	-	-

x, y - transducer cable length

l - max. length of extension cable

Transducer Cable

Technical Data

		transducer cable		extension cable	
type		1699	6111	1750	
standard length	m	see table above	see table above	5 10	
operating temperature	°C	-55...+200	-100...+225	< 80	
sheath					
material		stainless steel 304 (1.4301)	stainless steel 304 (1.4301)	stainless steel 304 (1.4301)	
outer diameter	mm	8	8	9	
cable jacket					
material		PTFE	PFA	PE	
outer diameter	mm	2.9	2.7	6	
thickness	mm	0.3	0.5	0.5	
color		brown	white	black	
shield		x	x	x	

Clamp-on Temperature Probe (optional)

Technical Data

order code		670415-1	670414-1	670415-2	670414-2
design		short response time			
type		Pt100	Pt100 matched according to DIN 1434-1	Pt100	Pt100 matched according to DIN 1434-1
connection		4-wire		4-wire	
measuring range	°C	-30...+250		-50...+250	
accuracy T		±(0.15 °C + 2 · 10 ⁻³ · T [°C]), class A		±(0.15 °C + 2 · 10 ⁻³ · T [°C]), class A	
accuracy ΔT		-	≤ 0.1 K (3K < ΔT < 6 K), more corresponding to EN 1434-1	-	≤ 0.1 K (3K < ΔT < 6 K), more corresponding to EN 1434-1
response time	s	50		8	
housing		aluminum		PEEK, stainless steel 304 (1.4301), copper	
degree of protection according to IEC/EN 60529		IP66		IP66	
weight (without connector)	kg	0.25	0.5	0.32	0.64
fixation		clamp-on		clamp-on	
accessories		-		plastic protection plate, insulation foam	
dimensions					
length l	mm	15		14	
width b	mm	15		30	
height h	mm	20		27	
dimensional drawing		A		B	

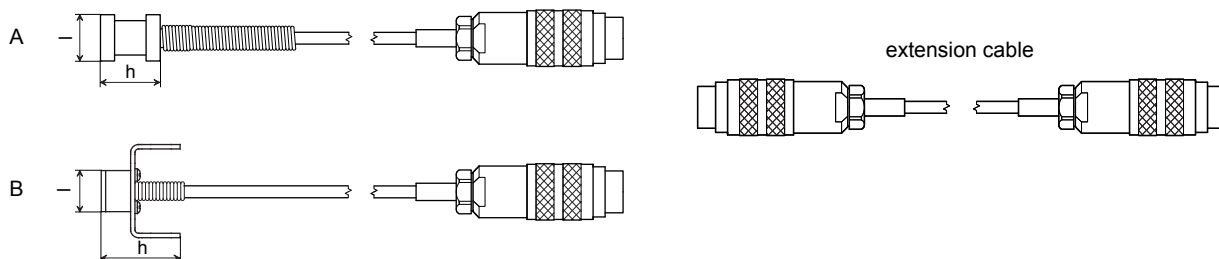

Connection

Temperature Probe

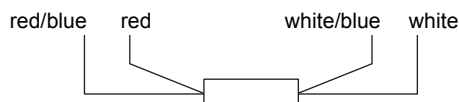

Connector

pin	cable of temperature probe	extension cable
1	white/blue	blue
2	red/blue	gray
3, 4, 5	not connected	
6	red	red
7	white	white
8	not connected	

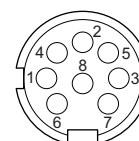

Cable

		cable of temperature probe	extension cable
type		4 x 0.25 mm ² black or white	LIYCY 8 x 0.14 mm ² gray
standard length	m	3	5/10
max. length	m	-	on request
cable jacket		PTFE	PVC



FLEXIM GmbH
Wolfener Str. 36
12681 Berlin
Germany
Tel.: +49 (30) 93 66 76 60
Fax: +49 (30) 93 66 76 80

internet: www.flexim.com
e-mail: info@flexim.com

Subject to change without notification. Errors excepted.
FLUXUS® is a registered trademark of FLEXIM GmbH.
TSFLUXUS_F608V1-4EN_Leu, 2011-03-03